



Cambridge International Examinations
Cambridge International General Certificate of Secondary Education

CANDIDATE NAME

CENTRE NUMBER

CANDIDATE NUMBER



PHYSICS

0625/51

Paper 5 Practical Test

October/November 2017

1 hour 15 minutes

Candidates answer on the Question Paper.

Additional Materials: As listed in the Confidential Instructions.

READ THESE INSTRUCTIONS FIRST

Write your Centre number, candidate number and name in the spaces at the top of the page.
Write in dark blue or black pen.
You may use an HB pencil for any diagrams or graphs.
Do not use staples, paper clips, glue or correction fluid.
DO NOT WRITE IN ANY BARCODES.

Answer **all** questions.
You are advised to spend about 20 minutes on each of questions 1 to 3, and 15 minutes on question 4.
Electronic calculators may be used.
You may lose marks if you do not show your working or if you do not use appropriate units.

At the end of the examination, fasten all your work securely together.
The number of marks is given in brackets [] at the end of each question or part question.

For Examiner's Use	
1	
2	
3	
4	
Total	

The syllabus is approved for use in England, Wales and Northern Ireland as a Cambridge International Level 1/Level 2 Certificate.

This document consists of **10** printed pages and **2** blank pages.

1 In this experiment, you will determine the weight of a load using a balancing method.

Carry out the following instructions, referring to Fig. 1.1.

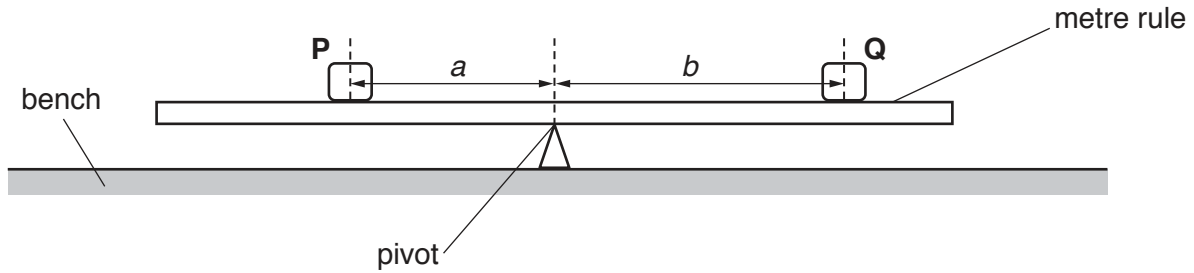

Fig. 1.1

- (a) Place the metre rule on the pivot and adjust its position so that the metre rule is as near as possible to being balanced. The 30.0 cm mark must be on the left-hand side of the pivot. **The metre rule must remain at this position on the pivot throughout the experiment.**

Place the load **P** on the metre rule so that its centre is exactly at the 30.0 cm mark on the metre rule.

Record the distance *a* between the 30.0 cm mark and the pivot.

a = cm [1]

- (b) Place a load **Q** on the metre rule and adjust the position of **Q** so that the metre rule is as near as possible to being balanced. Load **Q** has a weight *Q* of 1.0 N.

(i) Measure the distance *b* between the centre of load **Q** and the pivot. Record the weight *Q* and the distance *b* in Table 1.1.

(ii) Repeat the procedure, with the load **P** remaining at the 30.0 cm mark, using *Q* values of 2.0 N, 3.0 N, 4.0 N and 5.0 N. Record all the readings in the table.

Table 1.1

<i>Q</i> / N	<i>b</i> / cm	$\frac{1}{Q/N}$

- (iii) For each value of *Q*, calculate $\frac{1}{Q}$ and record the result in the table.

[3]

- (c) Plot a graph of b/cm (y -axis) against $\frac{1}{Q}/\frac{1}{N}$ (x -axis).

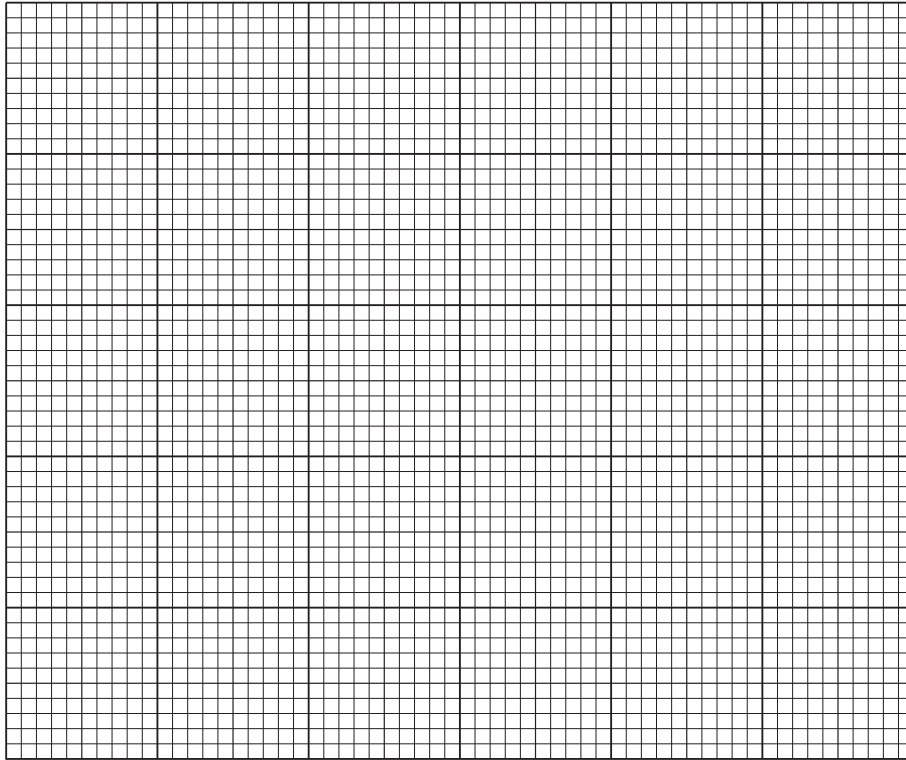

[4]

- (d) Determine the gradient G of the graph. Show clearly on the graph how you obtained the necessary information.

$$G = \dots\dots\dots [2]$$

- (e) Calculate the weight P of load **P** using the equation $P = \frac{G}{a}$.

$$P = \dots\dots\dots [1]$$

[Total: 11]

2 In this experiment, you will investigate resistance.

The circuit shown in Fig. 2.1 has been set up for you.

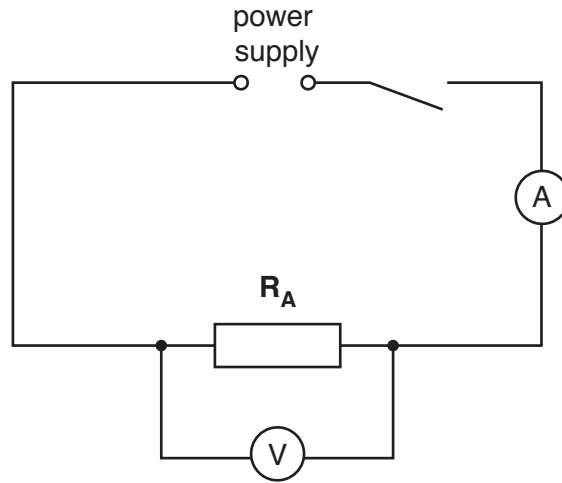

Fig. 2.1

- (a) (i) Switch on. Measure and record the potential difference V_1 across the resistor R_A and the current I_1 in the circuit.

$$V_1 = \dots\dots\dots$$

$$I_1 = \dots\dots\dots$$

[2]

- (ii) Switch off. Calculate the resistance R_1 of the resistor R_A using the equation $R_1 = \frac{V_1}{I_1}$.

$$R_1 = \dots\dots\dots[1]$$

- (b) Disconnect the voltmeter.

Connect the resistor R_B in series with R_A .

Connect the voltmeter across the two resistors R_A and R_B . Switch on.

- (i) Measure and record the potential difference V_2 across resistors R_A and R_B combined and the current I_2 in the circuit.

$$V_2 = \dots\dots\dots$$

$$I_2 = \dots\dots\dots$$

- (ii) Switch off. Calculate the resistance R_2 of resistors R_A and R_B combined in series, using the equation $R_2 = \frac{V_2}{I_2}$.

$$R_2 = \dots\dots\dots$$

[1]

(c) Disconnect the voltmeter.

Connect the resistor R_C in series with R_A and R_B .

Connect the voltmeter across all three resistors. Switch on.

(i) Measure and record the potential difference V_3 across the three resistors and the current I_3 in the circuit.

$V_3 =$

$I_3 =$ [1]

(ii) Switch off. Calculate the resistance R_3 of resistors R_A , R_B and R_C combined in series, using the equation $R_3 = \frac{V_3}{I_3}$.

$R_3 =$ [1]

(d) A student suggests that $R_3 = 3 \times R_1$.

State whether your results agree with this suggestion. Justify your answer by reference to your results.

statement

justification

.....

..... [1]

(e) Another student suggests that the three resistors, R_A , R_B and R_C , have the same value of resistance.

Explain how you could use the circuit shown in Fig. 2.1 to check this suggestion.

You are **not** required to carry out this experiment.

.....

..... [1]

(f) Complete the circuit diagram in Fig. 2.2 to show:

- the three resistors connected in parallel
- the voltmeter connected to measure the potential difference across the resistors
- a variable resistor connected to control the current in all three resistors.

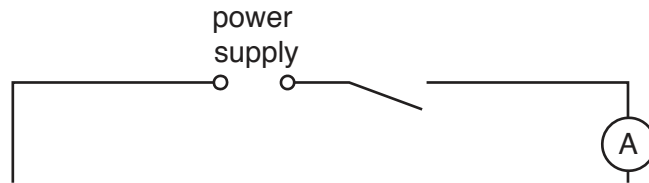

Fig. 2.2

[2]

(g) The circuit in Fig. 2.2 could be used to determine the combined resistance of three resistors connected in parallel.

Suggest a reason for connecting a variable resistor in the circuit.

.....

.....[1]

[Total: 11]

- 3 In this experiment, you will determine the focal length f of a lens.

Carry out the following instructions, referring to Fig. 3.1.

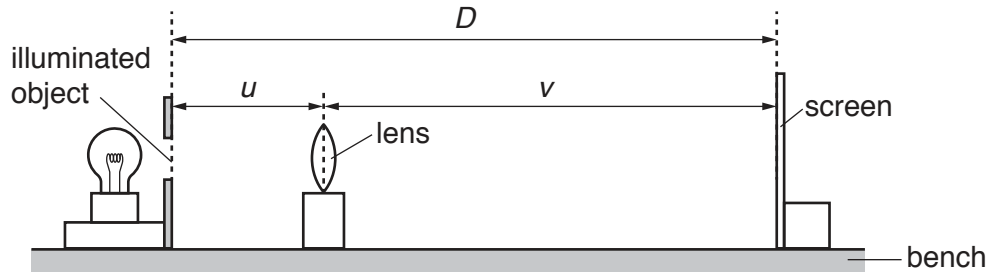

Fig. 3.1

- (a) Place the centre of the lens at a distance $u = 20.0$ cm from the illuminated object.

Place the screen close to the lens and move it away from the lens until a sharply-focused image is formed on the screen.

- Measure the distance v from the centre of the lens to the screen. Record v in Table 3.1.
- Calculate uv and record the result in the table.
- Measure and record in the table the distance D from the illuminated object to the screen. [3]

- (b) Repeat the steps in (a) with the lens at a distance $u = 30.0$ cm from the illuminated object. Record all the readings in the table.

Table 3.1

u/cm	v/cm	uv/cm^2	D/cm
20.0			
30.0			

[2]

- (c) State **one** difference that you observe between the image formed on the screen when $u = 20.0$ cm and when $u = 30.0$ cm.

.....
 [1]

- (d) (i) Use the results in the first row of the table to calculate a value f_1 for the focal length of the lens. Use the equation $f_1 = \frac{uv}{D}$.

$$f_1 = \dots\dots\dots$$

- (ii) Use the results in the second row of the table to calculate a value f_2 for the focal length of the lens. Use the equation $f_2 = \frac{uv}{D}$.

$$f_2 = \dots\dots\dots [1]$$

- (iii) Calculate the average value f_A for the focal length of the lens. Give your answer to a suitable number of significant figures for this experiment.

$$f_A = \dots\dots\dots [2]$$

- (e) Suggest **two** reasons why the results you have obtained may not be reliable.

1.

 2.
 [2]

[Total: 11]

- 4 A student is investigating whether the diameter of a pendulum bob affects the period of a pendulum. The period is the time taken for one complete oscillation of the pendulum. Fig. 4.1 shows a pendulum.

Fig. 4.2 shows one complete oscillation.

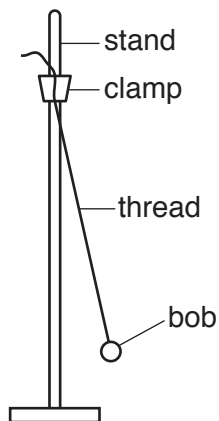

Fig. 4.1

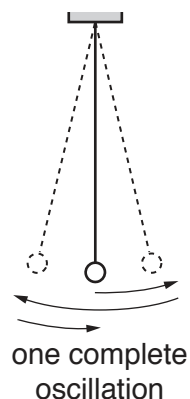

Fig. 4.2

The student has the following apparatus:

pendulum bobs made of polystyrene with diameters 1 cm, 2 cm, 3 cm, 4 cm and 5 cm
 a supply of thread and a pair of scissors
 clamp and stand

Plan an experiment to investigate whether the diameter of a pendulum bob affects the period of a pendulum. You are **not** required to carry out this experiment.

You should:

- list additional apparatus that you would require
- explain briefly how you would carry out the investigation
- state the key variables that you would control
- draw a table with column headings, to show how you would display your readings (You are **not** required to enter any readings in the table.)
- explain briefly how you would use your readings to reach a conclusion.

BLANK PAGE

Permission to reproduce items where third-party owned material protected by copyright is included has been sought and cleared where possible. Every reasonable effort has been made by the publisher (UCLES) to trace copyright holders, but if any items requiring clearance have unwittingly been included, the publisher will be pleased to make amends at the earliest possible opportunity.

To avoid the issue of disclosure of answer-related information to candidates, all copyright acknowledgements are reproduced online in the Cambridge International Examinations Copyright Acknowledgements Booklet. This is produced for each series of examinations and is freely available to download at www.cie.org.uk after the live examination series.

Cambridge International Examinations is part of the Cambridge Assessment Group. Cambridge Assessment is the brand name of University of Cambridge Local Examinations Syndicate (UCLES), which is itself a department of the University of Cambridge.